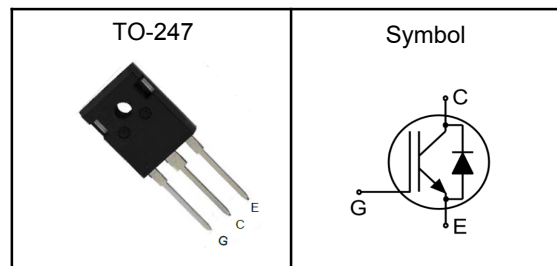

1200V/75A Trench FS II Fast IGBT
Features

- Trench FS II Technology
- Very low $V_{CE(sat)}$
- High speed switching
- ROHS Compliant

Applications

- Inverter welding machine
- Motor drives
- UPS

Pin Description

V_{CES}	1200	V
$V_{CE(sat)-Typ}$	1.7	V
I_C	75	A

Absolute Maximum Ratings ($T_C=25^\circ\text{C}$, Unless Otherwise Noted)

Parameter	Symbol	Rating	Units
Collector-Emitter Voltage	V_{CES}	1200	V
Gate- Emitter Voltage	V_{GES}	± 30	V
Collector Current ¹	I_C	150	A
Collector Current ¹	I_C	75	A
Pulsed Collector Current ²	I_{CM}	300	A
Diode Continuous Forward Current	I_F	75	A
Diode Pulsed Forward Current	I_{FM}	300	A
Power Dissipation	P_D	833	W
Power Dissipation	P_D	417	W
Storage Temperature Range	T_{STG}	-55 to 175	$^\circ\text{C}$
Operating Junction Temperature Range	T_J	-55 to 175	$^\circ\text{C}$

Thermal Characteristics

Parameter	Symbol	Typ	Max	Unit
Thermal Resistance Junction-Ambient	$R_{\theta JA}$	---	40	$^\circ\text{C/W}$
Thermal Resistance Junction to case for IGBT	$R_{\theta JC}$	---	0.18	$^\circ\text{C/W}$
Thermal Resistance Junction to case for Diode	$R_{\theta JCD}$	---	0.44	$^\circ\text{C/W}$



1200V/75A Trench FS II Fast IGBT

Electrical Characteristics ($T_J=25^{\circ}\text{C}$, Unless Otherwise Noted)

Parameter	Symbol	Conditions	Min	Typ	Max	Unit	
Collector-Emitter Breakdown Voltage	BV_{CES}	$V_{GE}=0V, I_D=3mA$	1200	---	---	V	
Collector-Emitter Saturation Voltage	$V_{CE(sat)}$	$V_{GE}=15V, I_C=75A,$	$T_J=25^{\circ}\text{C}$	---	1.7	1.95	V
			$T_J=175^{\circ}\text{C}$	---	1.95	---	V
Gate Threshold Voltage	$V_{GE(th)}$	$V_{CE}=V_{GE}, I_C=3mA$	4.5	---	6.0	V	
Collector-Emitter Leakage Current	I_{CES}	$V_{CE}=1200V, V_{GE}=0V$	---	---	400	μA	
Gate to Emitter Leakage Current	I_{GES}	$V_{GE}=\pm 30V, V_{CE}=0V$	---	---	± 200	nA	
Total Gate Charge	Q_g	$V_{CC}=960V,$ $V_{GE}=15V, I_C=75A$	---	572	---	nC	
Gate to Emitter Charge	Q_{ge}		---	69	---	nC	
Gate to Collector Charge	Q_{gc}		---	368	---	nC	
Turn-On Delay Time	$t_{d(ON)}$	$V_{CC}=600V, I_C=75A,$ $V_{GE}=15V, R_g=8\Omega,$ Inductive Load	---	19	---	ns	
Rise Time	t_r		---	17	---		
Turn-Off Delay Time	$t_{d(off)}$		---	170	---		
Fall Time	t_f		---	18	---	mJ	
Turn-On Switching Loss	E_{on}		---	5.6	---		
Turn-Off Switching Loss	E_{off}		---	2.7	---		
Total Switching Loss	E_{ts}	---	8.3	---			
Input Capacitance	C_{ies}	$V_{CE}=30V, V_{GE}=0V, f=1\text{MHz}$	---	9747	---	pF	
Output Capacitance	C_{oes}		---	327	---		
Reverse Transfer Capacitance	C_{res}		---	271	---		

Drain-Source Diode Characteristics

Parameter	Symbol	Conditions	Min	Typ	Max	Unit
Diode Forward Voltage	V_F	$I_F=75A, T_C=25^{\circ}\text{C}$	---	2.2	2.8	V
Reverse Recovery Time	t_{rr}	$I_F=37.5A,$ $di/dt=800A/\mu\text{s}, T_C=25^{\circ}\text{C}$	---	180	---	nS
Reverse Recovery Charge	Q_{rr}		---	4.3	---	μC
Diode Peak Reverse Recovery Current	I_{rrm}		---	29	---	A

Note:

- 1.The data tested by surface mounted on a 1 inch² FR-4 board with 2OZ copper.
- 2.The data tested by pulsed , pulse width $\leq 300\mu\text{s}$, duty cycle $\leq 2\%$

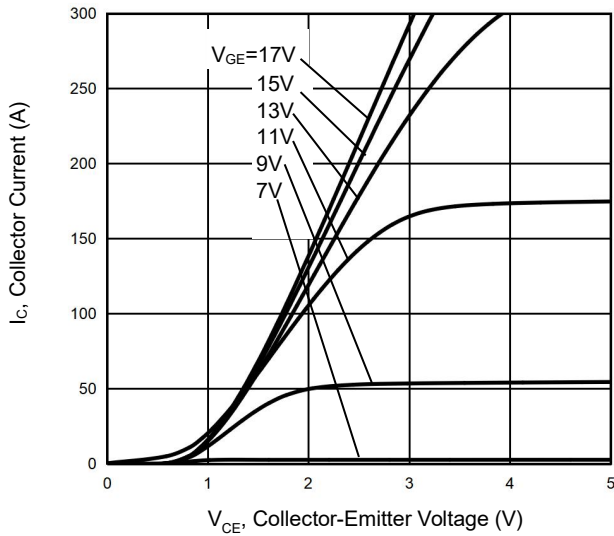
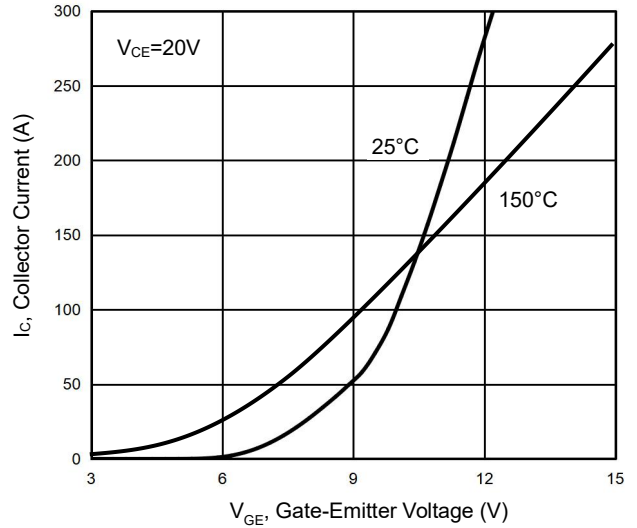
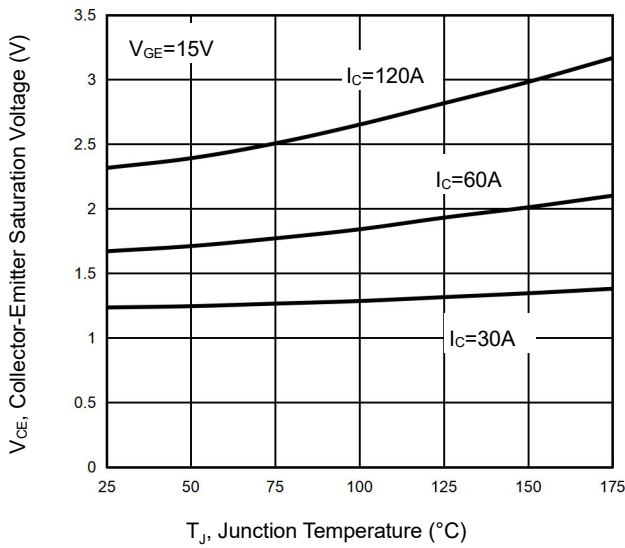
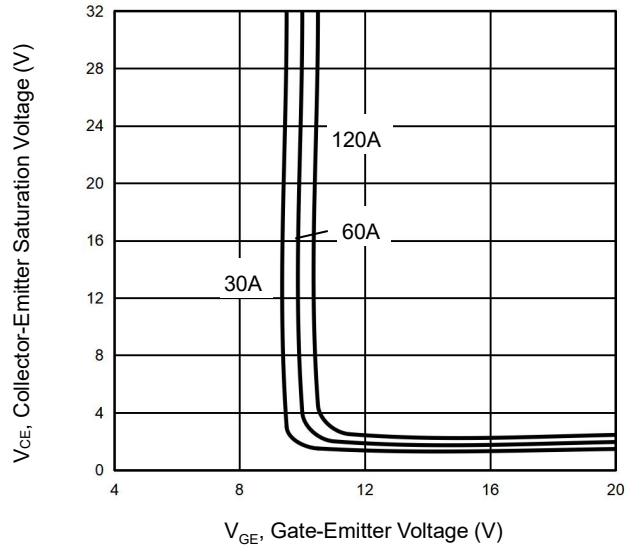
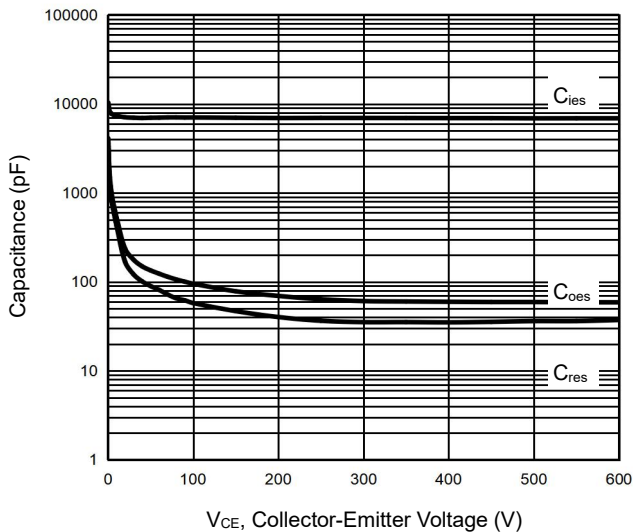
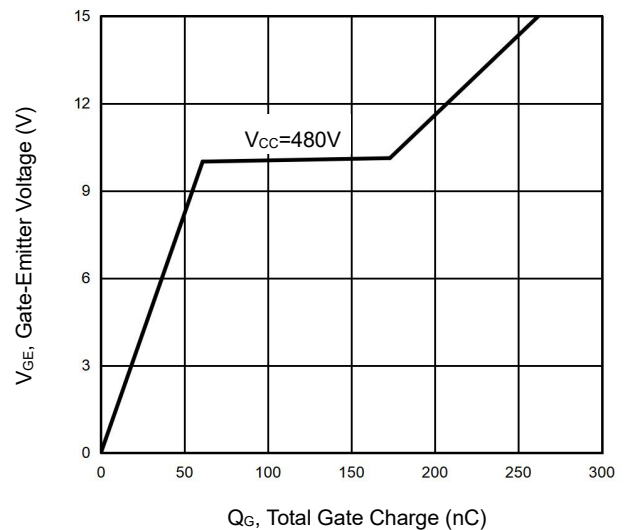
1200V/75A Trench FS II Fast IGBT
Typical Characteristics
Figure 1 Output Characteristics

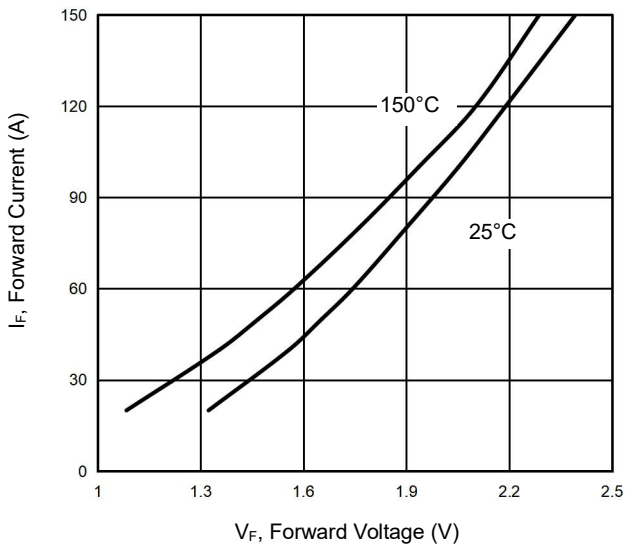
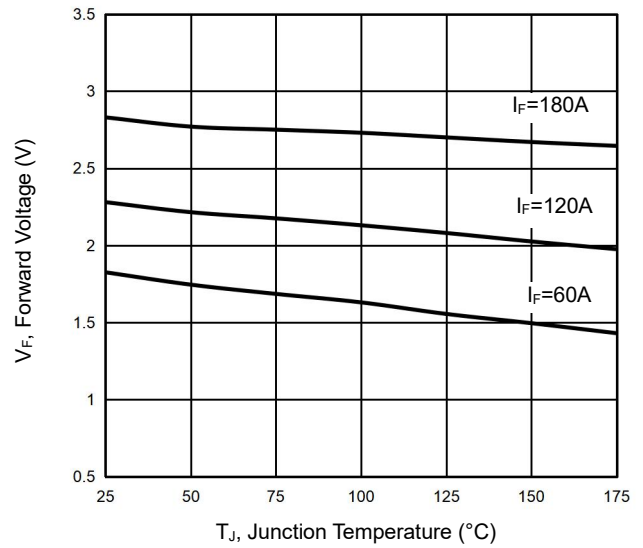
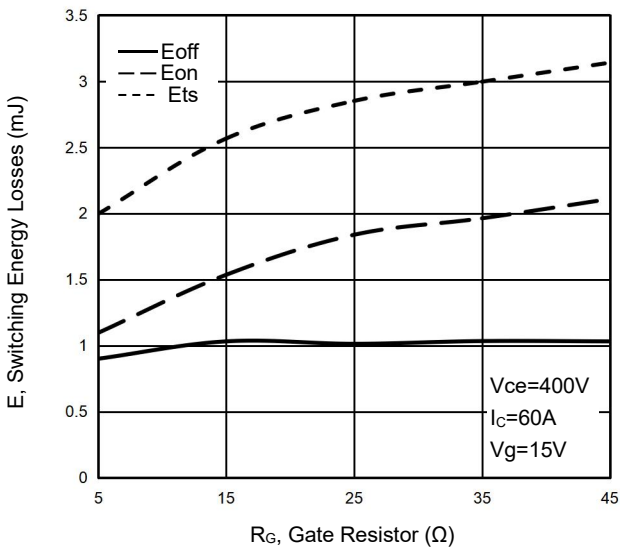
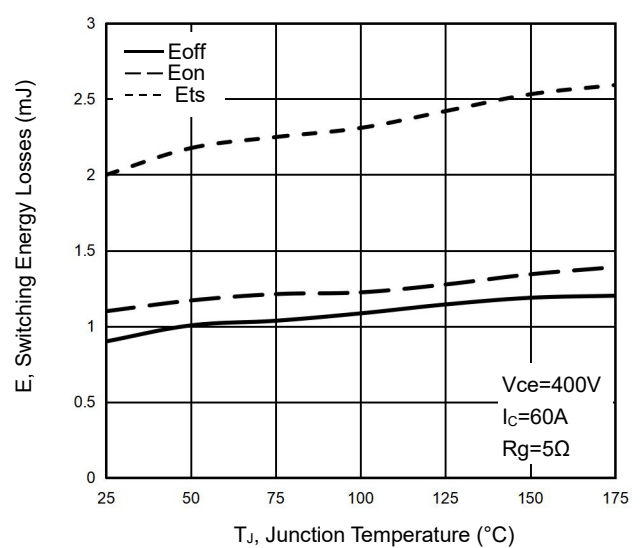
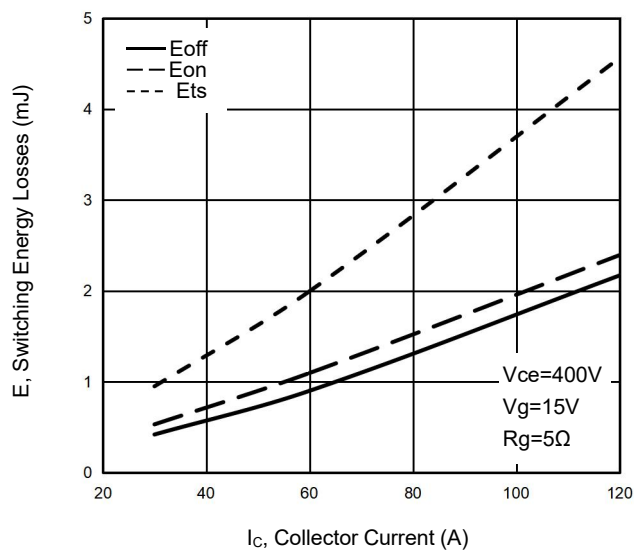
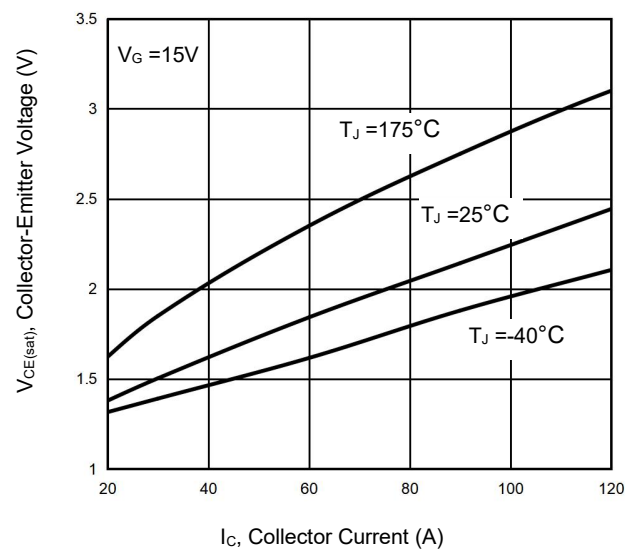
Figure 2 Transfer Characteristics

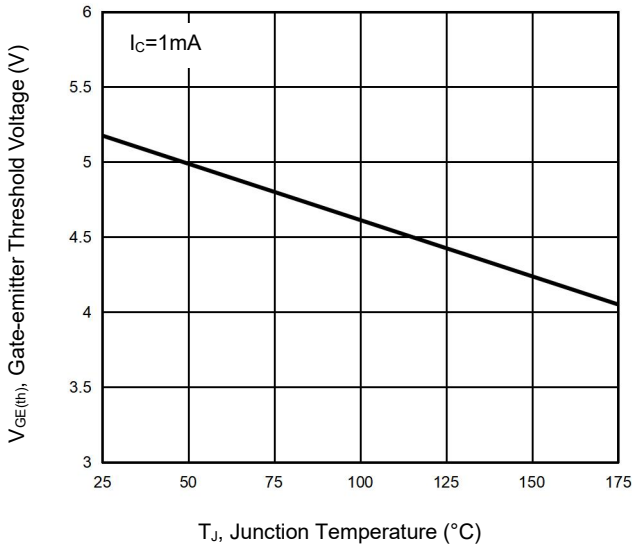
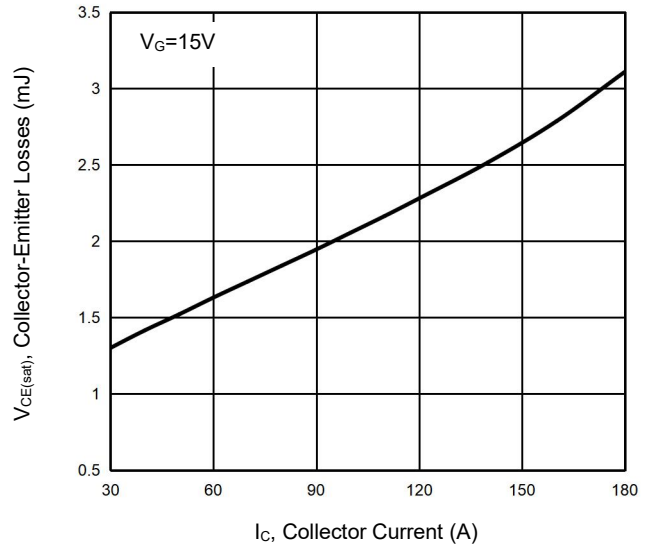
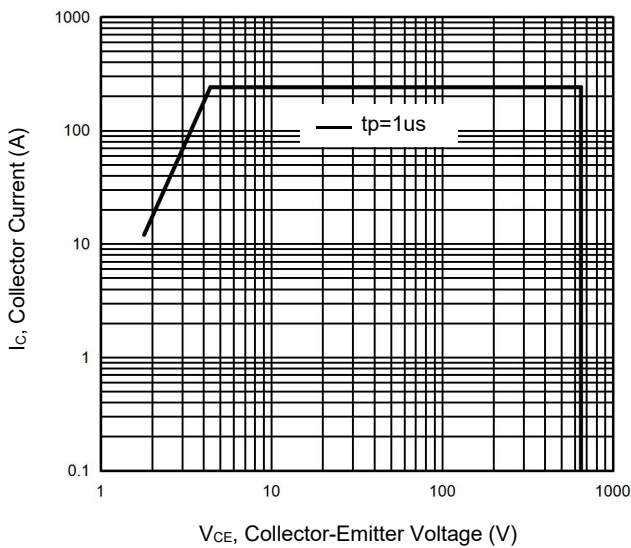
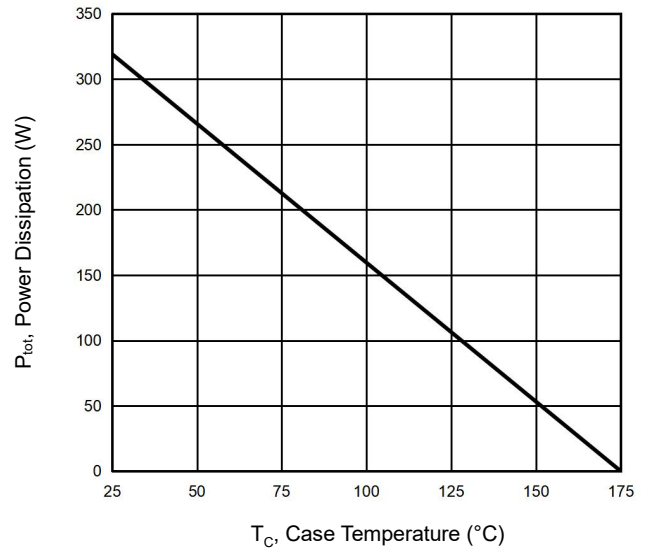
Figure 3 V_{CEsat} vs. Case Temperature

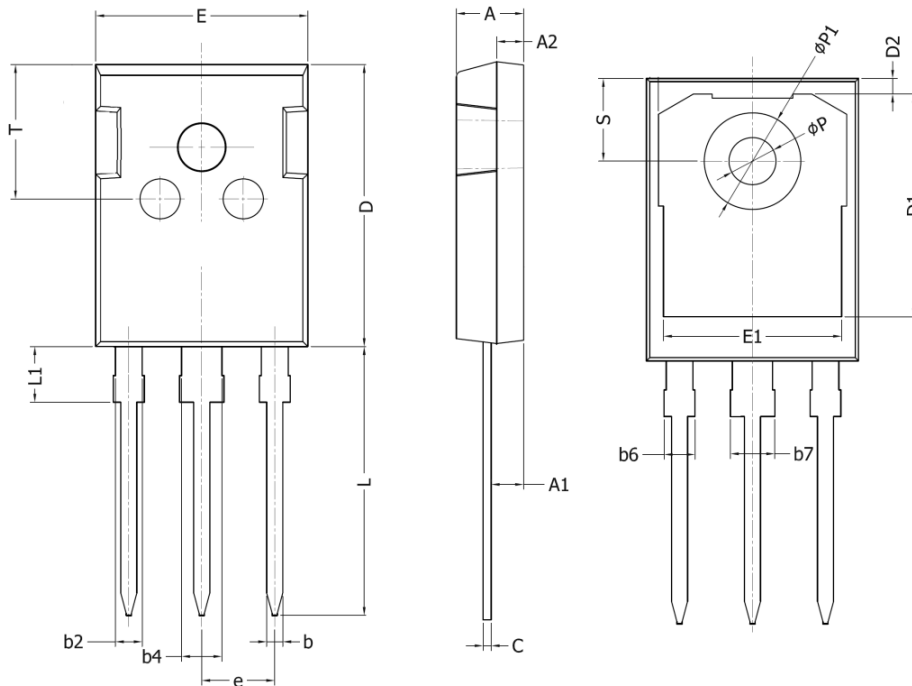
Figure 4 Saturation Voltage vs. V_{GE}

Figure 5 Capacitance Characteristics

Figure 6 Gate Charge Wave Form

1200V/75A Trench FS II Fast IGBT
Figure 7 Forward Characteristics

Figure 8 V_F vs. Temperature

Figure 9 Switching Loss vs. R_G

Figure 10 Switching Energy vs. Temperature

Figure 11 Switching Loss vs. Collector Current

Figure 12 $V_{CE(sat)}$ vs. Collector Current

1200V/75A Trench FS II Fast IGBT
Figure 13 $V_{GE(th)}$ vs. Junction Temperature

Figure 14 $V_{CE(SAT)}$ vs. Collector Current

Figure 15 Forward Bias Safe Operating Area

Figure 16 P_{tot} vs. Case Temperature

1200V/75A Trench FS II Fast IGBT
TO-247 Package Outline Dimensions

Symbol	Dimensions In Millimeters	
	Min.	Max.
A	4.90	5.20
A1	2.31	2.51
A2	1.9	2.1
b	1.16	1.26
b2	1.96	2.06
b4	2.96	3.06
b6	-	2.25
b7	-	3.25
C	0.59	0.66
D	20.90	21.20
D1	16.25	16.85
D2	1.05	1.35
E	15.75	16.10
E1	13.00	13.60
e	5.436 BSC	
L	19.80	20.20
L1	-	4.30
P	3.40	3.60
P1	7.00	7.40
S	6.05	6.25
T	9.80	10.20